

Boulder Amateur Television Club TV Repeater's REPEATER

April, 2024
3ed edition, issue #160

BATVC web site: www.kh6htv.com

ATN web site: www.atn-tv.com



Jim Andrews, KH6HTV, editor - kh6htv@arri.net www.kh6htv.com

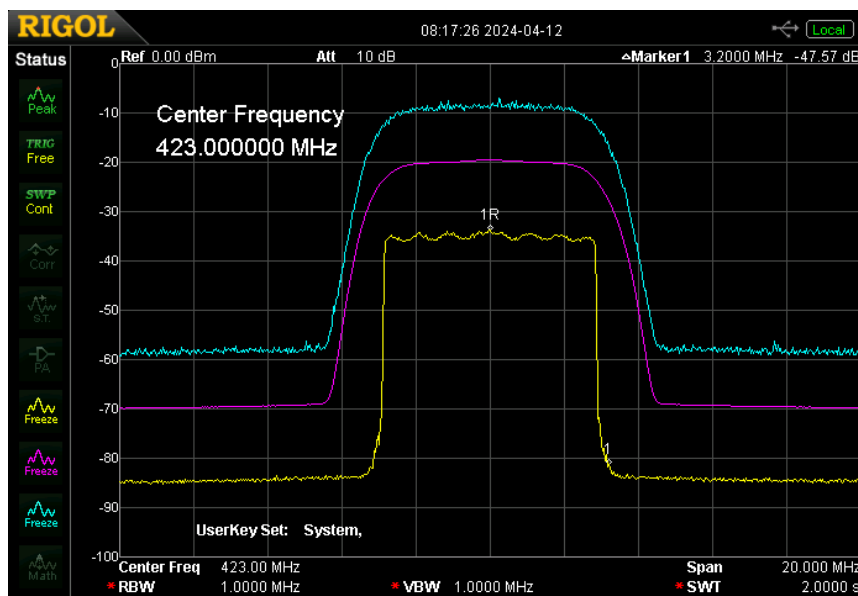

10 dB/div & 2 MHz/div

PEAK vs. RMS in a DVB-T Signal

How much head-room do we need to allow in our amplifiers to accommodate the peaks in the noise-like DVB-T signal ? The text books tell us the Crest Factor, i.e. the theoretical peak to rms difference is about 40 dB. They also say the probability of that ever occurring is extremely unlikely, so in the real world rf power transmitter it is more of the order of 13 dB. I decided to try an

experiment using my Rigol DSA-815 spectrum analyzer as my measurement tool. The above screen capture photo shows the results.

I used my Hi-Des HV-320E, DVB-T modulator as my signal source. I set it up for 423 MHz with 6 MHz band-width and QPSK modulation and the internal attenuator set to -20dB. With these settings, I measured the total rf power to be -11.6dBm on my HP-432, thermistor rf power meter.

The yellow trace shows the standard setup for measuring a DVB-T signal, per the ITU recommendations. RMS detector, 30 kHz resolution bandwidth, 300 kHz video bandwidth, and 2 second sweep. I also used 10 sweep averages. The power measured at center frequency of 423 MHz was -33.8dBm. Thus to determine the total channel power for a 6 MHz wide TV channel, the correction factor is 22.2dB.

Next, I changed the resolution and video bandwidths to highest possible setting of 1 MHz. The magenta trace resulted. Now at 423 MHz, we measure -19.6dBm. I then changed the detector from RMS to Peak and put the display in Max. Peak Hold mode. The cyan trace resulted. Now for it at 423 MHz, we measure -9.2dBm. Thus from this I conclude the difference for this DVB-T signal of the highest peaks in the signal relative to the RMS value is $19.6 - 9.2 = 10.4$ dB.

73 de Jim, KH6HTV, Boulder, Colorado

23cm Repeater Antennas - Feedback: **(Hustler Spirit Antennas)**

Hi Jim --- I agree with your conclusions about the X6000 for repeater use. I have consistently found that the Hustler Antennas (www.new-tronics.com) Spirit Series of antennas are the only way to go on 1.2 GHz (As you know we have many hill tops with them). I would recommend the following: HS10-12430-DT-2. You can custom order the antenna cut to your frequency and the DT-2 is 2 degrees electrical down tilt. You can also ask for null fill as well to help fill in between the major lobe and first lower minor lobe. If you do not need as much down tilt, then DT-1.5. You can also order a reflector element or roll your own. 1/4 wave spacing gives you the best lobe to the east and 1/2 wave reflector spacing higher gain up and down the valley with 2 to 3 dB more gain in the desired direction and about unity off the back.

I would suggest checking the tilt from the repeater to the closest station, then do the same for the one out in the fringe. Split the difference and that is usually the DT desired. I have used a 12 dB version, It is on Santiago Peak with 1.5 degree downtilt and 5% null fill. In the Santiago case the nearest station is 12 miles out and the hill is 5600 ft and average ground is about 200 to 1500 ft in the coverage area. At Snow Peak, an 7900 ft site, I use a 10 db with 3 degrees downtilt, 5% null fill and a reflector to get away from the San Gorgonio 11k mountain reflection just behind the site. DX Engineering and HRO have the antennas or order them for you.

73, Mike Collis, WA6SVT, Crestline, California --- ATN

Editor's Notes: Here is the specs. from Hustler for the 23cm spirit antennas. Following up on Mike's lead, we do find them listed on the HRO web site, but quite expensive antennas. HRO listed prices for the 6, 9 & 12dBd versions at \$490, \$625 and \$770 respectively.

**Hustler Antenna
Amateur Base Spirit Antenna 1.2-1.3 GHz**

Model Number:

- HS6-12430 (6 dBd)
- HS9-12430 (9 dBd)
- HS10-12430 (10 dBd)
- HS12-12430 (12 dBd)

- o **Gain:** 6 dBd, 9 dBd, 12 dBd
- o **Bandwidth:** 80 MHz.
- o **V.S.W.R.:** 1.5:1
- o **Polarization:** Vertical
- o **Power Rating:** 300 Watts Maximum
- o **Termination:** Type N Female
- o **Vertical Aperture (3 dB from max.):**
 - 18 degrees (6 dBd)
 - 4 degrees (12 dBd)
- o **Weight:** 10 lb.
- o **Wind Load (Lateral thrust @ 100 mph):** 52 lb.
- o **Wind Area (flat plate equivalent):** 1.2 sq. ft.
- o **Maximum Wind Speed:** 160 mph
- o **Material Feed Lines:** Copper
- o **Radiators:** Copper
- o **Color Radome:** White Fiberglass
- o **Mounting:** Galvanized steel mounting clamps to a support pipe up to 3.25" O.D.
- o **Lightning Protection:** Direct Ground

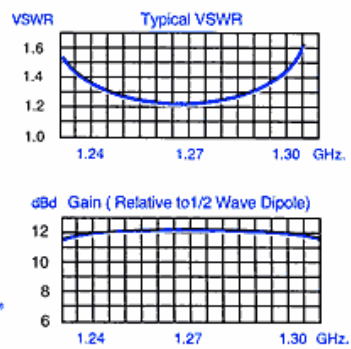
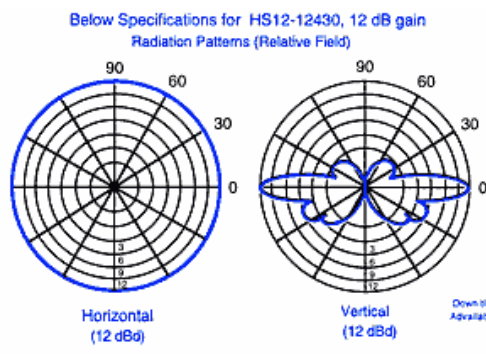
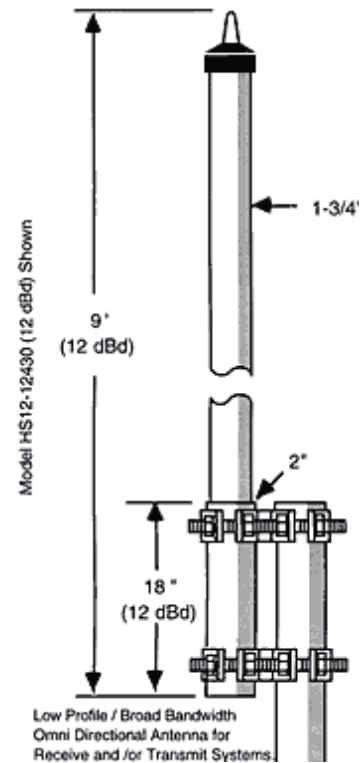

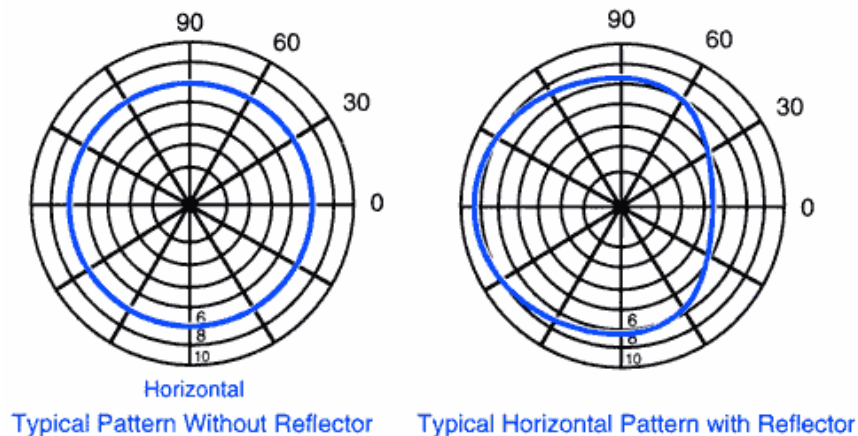

Feed-Back on 70cm BPFs

Hi Jim --- I was reading the latest Boulder newsletter and the article on DATV filters for 70cm. I had a bright idea a few years ago to use a 70cm duplexer as a bandpass filter. The signal goes through all six cavities to get a sharp response. I could use three for a less sharp response but less insertion loss. It is very easy to set up and they are quite cheap. It is possible to do the same thing on other bands. There is also a blog post on a commercial filter that I think the Melbourne repeater uses.

<https://vk4zxi.blogspot.com/2018/07/commercial-low-power-uhf-dvb-t-pass.html>

The filter is from COM-TECH Italia SpA -- <http://www.com-tech.it/products/cl-series-c/>

I enjoy the Boulder newsletter as there is more of the type of DATV that I do in Australia.

Regards Drew Wollin, VK4ZXI,

A 70cm DATV, DVB-T, 7 MHz, Band-Pass Filter Using a Cheap Chinese Duplexer

Drew Wollin, VK4ZXI

Introduction -- DATV transmitters for DVB-T are notorious for "spread" outside the channel, to the point that keeping it 30 dB or more below the signal becomes a limit for power output, typically 10 W out of a 70 W module amplifier.

Even with -30 dB spread, it is desirable to have a band-pass filter before further amplification or transmission. Usually an interdigital filter is used, but they are either expensive to buy or a bit difficult to build.

VK4JVC suggested using a cavity filter duplexer instead. I tried a four cavity notch duplexer, but the pass-band losses were too high, more than 20 dB. I had bought a cheap, ~A\$100, Chinese Jiesai duplexer, but had put it aside as the response looked bad. After try other duplexers (notch and pass-reject types), I tried the Chinese one again, this time successfully.

The result is that the Chinese filter seems to provide a good pass-band for the 7 MHz DVB-T DATV signal with acceptable pass-band losses and steep skirts. The next test is to try it with my 10 W amplifier from Darko in Austria.



The FILTER --- The duplexer is a typical mobile device available on eBay for about A\$100 delivered, taking a week or so to Australia. The store insisted I supply some tuning data, even though I was immediately going to change it. I specified 440.5 and 446.5 MHz to keep them happy. It came with notches at those frequencies, but had not been well tuneThe filter

The duplexer is a typical mobile device available on eBay for about A\$100 delivered, taking a week or so to Australia. The store insisted I supply some tuning data, even though I was immediately going to change it. I specified 440.5 and 446.5 MHz to keep them happy. It came with notches at those frequencies, but had not been well tune

The filter has three square cavities for each of RX and TX. The only adjustment is a screw at the top that capacitively alters the cavity's resonate frequency. There are no other adjustments. Each cavity has an cable in and out, but they seem to be notch filters rather than pass-band.

I am not sure what the power handling capacity is, 25 W, from memory. That would make it an adequate final TX filter for most DATV applications.

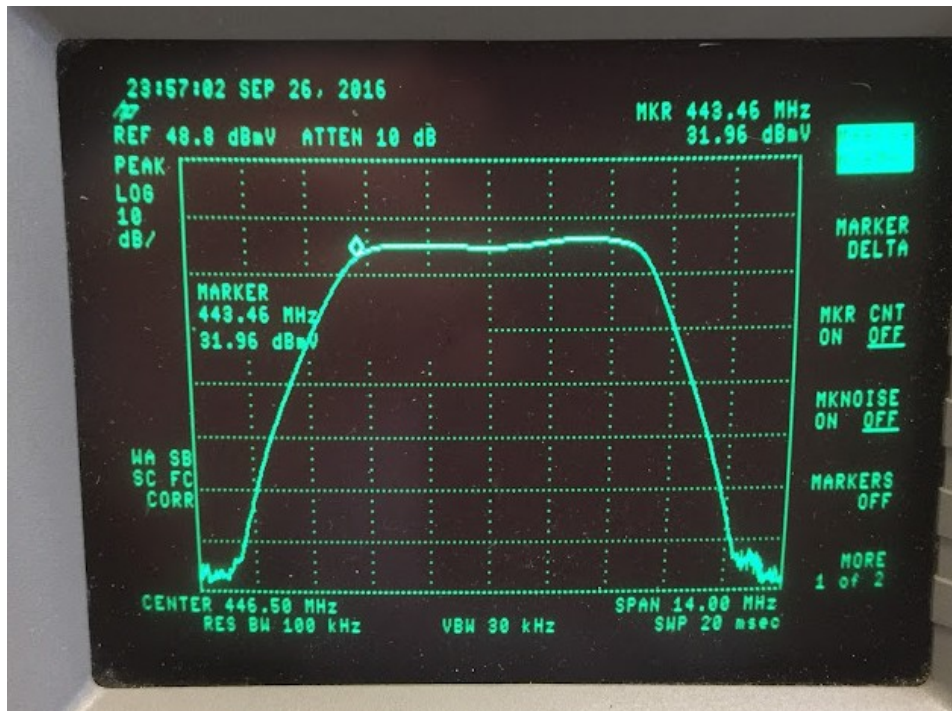

TUNING --- The Australian 70 cm DATV band is 7 MHz wide centered on 446.5 MHz, with edges at 443 and 450 MHz. I use the whole 7 MHz as it makes reception on conventional TVs easier and I want high quality 1080p.

Using a HP 8591A spectrum analyser and tracking generator, re-tuning is quite easy. Three cavities at a time first (RX-ANT, TX-ANT), then checking all six with the input and output through the RX and TX connectors, ignoring the antenna connector.

I have tuned the cavities to about -3 dB at the channel edges. The loss through all six cavities is about 2 dB which indicates quite reasonable construction. The side slopes are quite steep.

I am not sure this tune will be adequate to suppress the channel spread, but I will re-tune to find an acceptable compromise. I may need to narrow the width, but without affecting the TX signal.

CONCLUSION --- A cheap Chinese duplexer has been re-tuned to produce what appears to be an acceptable TX band-pass filter for a 7 MHz wide channel on 70 cm.

Despite their reputation, the Chinese duplexer seems of reasonable quality and has typical characteristics for this type of device. The original tuning was indifferent, so should always be checked.

reprinted with permission from VK4ZXI, Drew Wollin's blog from 26 Sept. 2016.

<https://vk4zxi.blogspot.com/2016/09/a-70cm-datv-tx-filter-using-cheap.html>

He also has a follow-on blog entitled "Testing a duplexer as a DVB-T TX filter - Wow !"

<https://vk4zxi.blogspot.com/2016/09/testing-duplexer-as-dvb-t-tx-filter-wow.html>

More Feed-Back on FM-TV with IC-905:

ATV and Icom IC-905: Radio Amateur ATVs have not had, do not have, much compression from the big companies like Icom, Yaesu, ... In the past, the companies Icom, Yaesu, ... have also tried to deal with ATV problems, but with little success. Yaesu has released the TV-736 (for FT-736R). Icom has put on the market the TV-1200 (for IC-1271), TV-1275 (for IC-1275), the RX IC-R9500 and today the IC-905. The Icom IC-905 is interesting for ATV because it allows ATV connections in 1.2 GHz, 2.4 GHz, 5.6 GHz and 10 GHz in FM and because it stays on FM connections.

Icom ignored DVB-S, DVB-2S, DVB-T, DVB-T2, ATSC, DTMB, ISDB-T in ATV.

The Icom IC-905 accepts – receives signals from our ATV FM TXs, but does not accept them WELL. It is not 100% compatible in transmission with our ATV FM RX or satellite RX. Let's hope that, as in the past, this IC 905 will not go down in history as a "flop"

73 de Rudi Pavlic, S58RU, Koper, Slovenia

Please give us the opportunity to use all of our analogue FMTV systems in conjunction with IC-905

Darko Banko, OE7DBH

For decades, many of us still use FM-TV in amateur radio, under the name FM-ATV from 1200 MHz to 24 GHz. There are also many repeaters in exposed locations that still use analogue technology, even if digital technology has also been added. All users who made or do ATV back then and now still have analog transmitters and receivers at home. Transmitters were mostly self-made (no matter who made them). Nobody built receivers, they simply bought customer receivers and used them in conjunction with a pre-amplifier or a down-converter. These receivers were all built according to one standard, this standard is: Bandwidth 27 MHz or 36 MHz, in rare cases 15 MHz, most receivers only had 27 MHz. All transmitters were adjusted to this 27 MHz in order to get a perfect image in the monitor 1 Vpp at 75 ohms. It worked so well for decades.

A perfect image that was sent out perfectly only comes out perfectly on a screen if: Receiver works well, correct reception frequency and correct bandwidth have been set !! What does a perfect video signal look like to a wave monitor ?and what does it look like on the user screen.

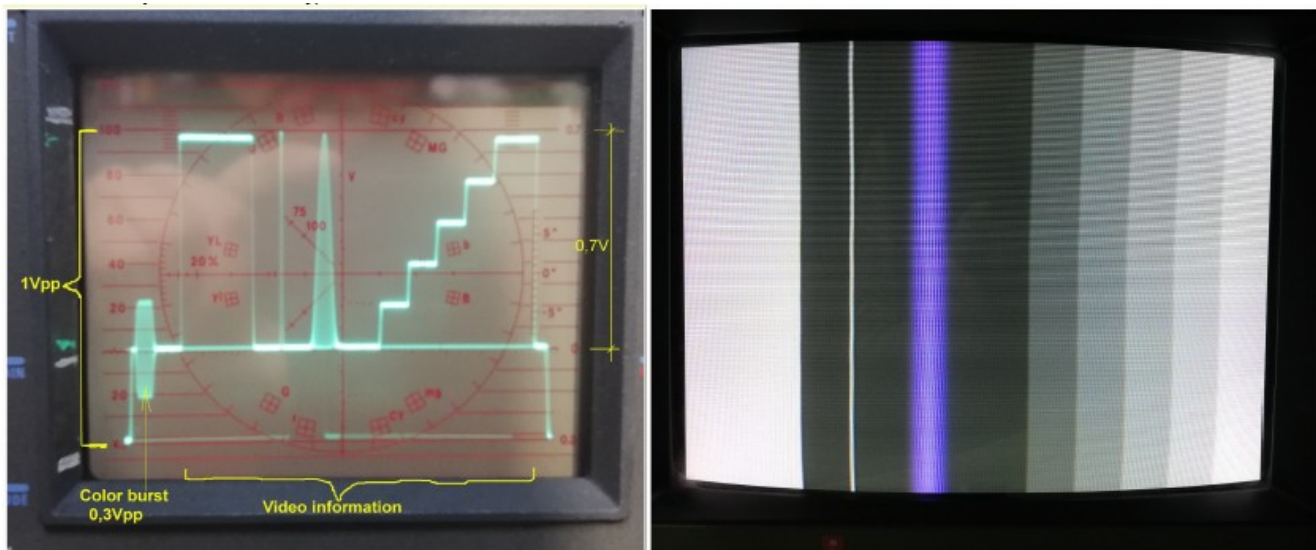

This is roughly how we have received our images so far with a bandwidth of 20~27MHz.

Since 2023, new players have arrived on the field. IC-905 We ATV amateurs have great hope for this device, why not ? FM-ATV in all frequencies from one device. I also have no doubt that it doesn't work between two identical IC-905. But it doesn't work properly with the customer devices we've used so far. We cannot combine customer receiver with IC-905 FM-TV transmitter. This will mean that all interested TV amateurs will have to buy an IC-905 and throw away the customer receiver they have been using up to now. I bought one and was disappointed, I don't have another 5000 euros for a second IC905. Why doesn't this combination between IC-905 and customer receiver work ? Because IC-905 transmitted signal does not have enough width to be demodulated in customer receiver. (too little for 15 MHz for PACE receiver and not enough for other receivers with 27 MHz)

OK, then let's see what this standard COMPOSITE signal looks like sent with my IC-905 10MHz bandwidth and received with the PACE Receiver.

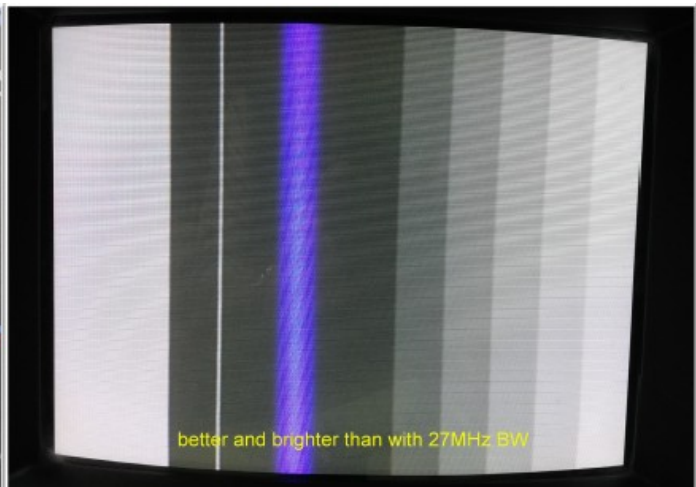
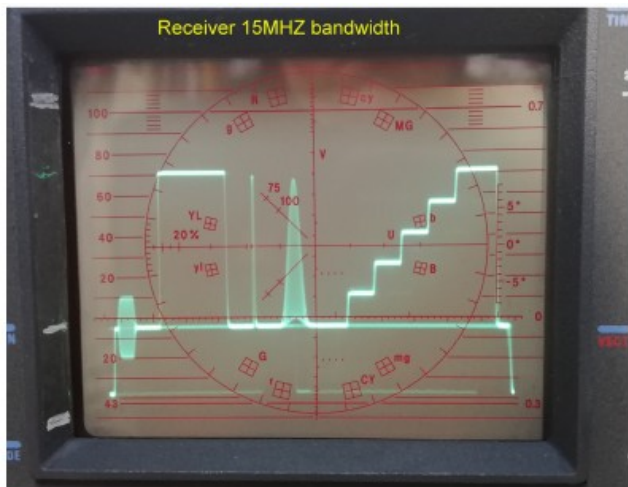
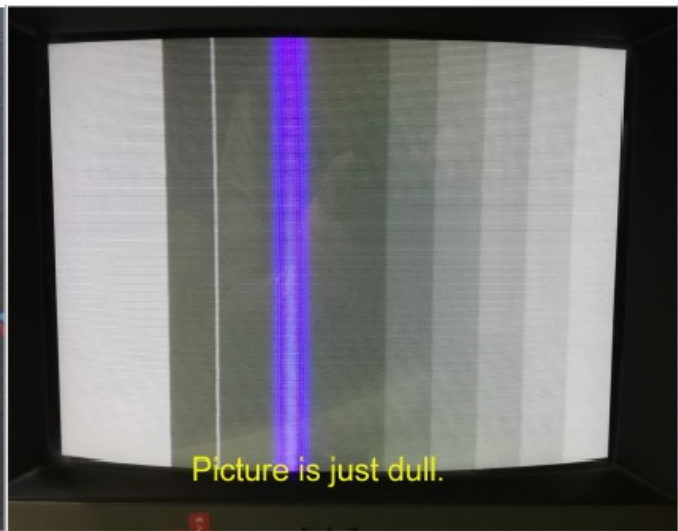
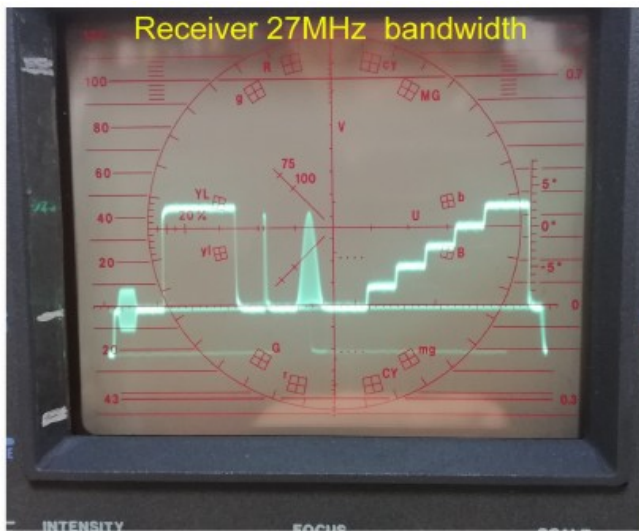

These are clearly not satisfactory results !!!.

Let's turn our field of vision to the IC-905 , what setting options does it have in terms of bandwidth ?. There are already 5MHz, 10MHz and 17MHz bandwidths , but not 27MHz bandwidth (that would be the correct bandwidth for standard consumer receivers).

We could still get around this 27 MHz too little modulation !. If it is not possible to add 27MHz, how to work around ? → Stay at 17 MHz setting and give more video modulation !!



And that's exactly where the next problem is, software doesn't allow settings above 60% !!!! (TX LED starts flashing and it stops sending). A software settings lock is built in.

Dear ICOM technicians, dear ICOM team, please please remove this software setting lock in the next software update and let us combine IC-905 with other receiver devices.

We want to enjoy FM-TV again, and especially now with this new device, don't let it be a flop.

Best regards Darko Banko, OE7DBH, Pians, Austria

Editor's Comments: *While I understand these hams frustrations with the new IC-905, I can also sympathize with the ICOM engineers in the choices they had to make when designing this new microwave, amateur, all-mode (almost) transceiver.*

First -- like it or not, analog TV in most any form is a mode of the past. Yes, it had many advantages, plus disadvantages. But unless you are willing to roll your own equipment today, you are almost completely out of luck. With the sole exception of some great drone FM-TV gear for 5.8 GHz, I have yet to find anything else available on the market to purchase. If you want to buy FM-TV gear, for any band now, or even 70 cm AM-TV, you have to find it as old, used, surplus at swap-fests, garage sales, etc.

2ed --- It is a dead give away in the first paragraph dealing with 27/36 MHz band-width receivers, Darko's comment "*It worked so well for decades.*" Those were the original analog satellite TV receivers dating back to the 1970s-80s. They disappeared from the market place many, many years ago when satellite TV transitioned to digital. We are not talking decades, but 1/2 century ago !

3ed --- Lack of Uniform Standards. Unlike our USA, NTSC, analog TV which was standardized in 1941 at 6 MHz rf band-width, 4.2 MHz video band-width, 1 Vpp (75 Ω), 4.5 MHz FM SSC, etc. --

FM-TV had lots of variations, particularly on the rf side. There were various FM deviations used. Some transmissions used pre-emphasis / de-emphasis, while others did not. Not to mention the differences in NTSC, PAL, etc. for the pre-de emphasis circuit. Then for the sound, there was not any real standard on which sub-carrier frequency to use. So even in the "good old days", we had lots of incompatibility issues to deal with from one manufacturer to another and one ham group to another.

I encountered this myself a dozen years ago, when I tried to be a manufacturer of FM-TV gear for the amateur market. I came up with some cool products, I thought, for the 23cm band. An FM-TV modulator, a complete 3 Watt transmitter, a down-converter and a 70 MHz IF amplifier/ FM-TV demodulator. I tried to design them with a lot of flexibility for the user to customize them as he needed with adjustable deviation, adj. SSCs, with/with out deemphasis, etc. But to no avail. No one wanted to buy them. I only ever sold one modulator, two of the transmitters, and two of the IF amp/demodulators. The down-converters sold a bit better, if you say selling nine of them over a 10 year span is better. I don't !

4th -- Omission of Digital TV from the IC-905 I can understand ICOM leaving this out. Digital TV requires a huge amount of computing horsepower to accomplish. Look inside your present DTV gear. They contain powerful computing ICs to pull it off. Plus, again, look at all the various options for DTV. We have DVB-T, DVB-S, ATSC, etc. etc. etc. Again no world-wide standardization. Do you want ICOM to also throw in the kitchen sink in your new rig --- plus pay not \$5K Euros / Dollars, but \$20K ?

OK --- Now let's hear from other newsletter readers on the subject.

73 de Jim Andrews, KH6HTV, Boulder, Colorado

ATV at Dayton Hamvention

All ATVers planning on attending the annual Dayton Hamvention this year need to put on their "must-do" list three items. 1. Attend the ATV Friday night dinner, 2. Attend the Saturday ATV Forum and 3. Visit the ATV booth. It will be booths 2003 & 2004, in the west building on the left side. Look for the ATCO & ATN banners. The NEW VersaTune receiver will be on display.

May 17. ATV Friday Night dinner. The ATV Dinner will be at the China Garden Buffet restaurant starting at 6:30PM on 112 Woodman Drive in Dayton, Ohio 45431 (Airway Shopping Center) on May 17. Buffet Dinner \$15.99 (937-781-9999). We have dinner then presentations about various ATV topics and door prizes concluding about 9 PM.

May 18. ATV Forum Forum will be on Saturday at 10:30 AM in room 4. The presenters so far will be: 1. Art Towslee WA8RMC Introduction 2. Gordon West WB6NOA Warm up. Some humor with a couple of one liners. 3. Art Towslee WA8RMC DATV basics. DVB-S, DVB-T Comparison & analog ATV operation. and 4. Mike Collis WA6SVT, ATN California summary

ATV - Public Relations: We are getting more publicity these days about ATV. Jim, KH6HTV, has gotten more requests to present his 1 hour lecture on ATV on more ham club Zoom meetings. On April 10th, it was to the Surry Amateur Radio Communications club in Surrey (Vancouver), B.C. Canada. (www.ve7sar.net) On April 25th, it was to an on-line ham radio school called "National Zoom Session - Operating Classes" organized by Rol, K3RA, in Maryland. (roland.anders@comcast.net) Rol reported there were about 160 on-line participants for the ATV class.

WOBTV Details: **Inputs:** 23 cm Primary (CCARC co-ordinated) + 70 cm secondary all digital using European Broadcast TV standard, DVB-T 23cm, 1243 MHz/6 MHz BW (primary), plus 70cm (secondary) on 441 MHz with 2 receivers of 6 & 2 MHz BW
Outputs: 70 cm Primary (CCARC co-ordinated), Channel 57 -- 423 MHz/6 MHz BW, DVB-T Also, secondary analog, NTSC, FM-TV output on 5.905 GHz (24/7 microwave beacon).
Operational details in AN-51c Technical details in AN-53c. Available at:
<https://kh6htv.com/application-notes/>

WOBTV ATV Net: We hold a social ATV net on Thursday afternoon at 3 pm local Mountain time (22:00 UTC). The net typically runs for 1 to 1 1/2 hours. A DVD ham travelogue is usually played for about one hour before and 1/2 hour after the formal net. ATV nets are streamed live using the British Amateur TV Club's server, via: <https://batc.org.uk/live/> Select *ab0my or n0ye*. We use the Boulder ARES (BCARES) 2 meter FM voice repeater for intercom. 146.760 MHz (-600 kHz, 100 Hz PL tone required to access).

Newsletter Details: This is a free newsletter distributed electronically via e-mail to ATV hams. The distribution list has now grown to over 700+. News and articles from other ATV groups are welcomed. Permission is granted to re-distribute it and also to re-print articles, as long as you acknowledge the source. All past issues are archived at: <https://kh6htv.com/newsletter/>

ATV HAM ADS -- Free advertising space is offered here to ATV hams, ham clubs or ARES groups. List here amateur radio & TV gear

For Sale - or - Want to Buy

ITEMS FOR SALE OR GIVE AWAY:



SLATS

ST. LOUIS AMATEUR TELEVISION SOCIETY

Buy - Sell - Trade - Giveaway

WWW.SLATSATN.NET



NVIDIA GeForce 8800 GTS VIDEO CARD



SMD EXTRACTOR (desoldering) TOOL



"TALKING" VHF/UHF TW-2 WATT METER